

Trusted. Tested. Tough.®

Product information presented here reflects conditions at time of publication. Consult factory regarding discrepancies or inconsistencies.



SECTION: 2.70.010

FM0487

1120

Supersedes

0516





MAIL TO: P.O. BOX 16347 • Louisville, KY 40256-0347
 SHIP TO: 3649 Cane Run Road • Louisville, KY 40211-1961
 TEL: (502) 778-2731 • 1 (800) 928-PUMP • FAX: (502) 774-3624

Visit our website:
 zoellerpumps.com

SUMP/SEWAGE BASINS COMPARE THESE FEATURES

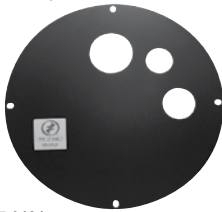

- Available in high density polyethylene structural foam (PSF), polyethylene or fiberglass
- Ideal for residential, commercial and industrial applications
- Complete with necessary sealing hardware and flanges
- Available with 2" or 3" vent and 2" or 3" discharge
- Lid with gasket and 4" cast iron inlet hub with anticorrosion coating are included with the sewage basins
- Centerline of hub is located 10-1/2" from top of basin (std.). Custom locations available
- Polyethylene sewage pump basins are IAPMO approved. For 10' stacktest models, refer to charts on pages 2 and 3
- Sealed (Radon) basins for sump pumps in 18" x 22" and 18" x 30" sizes
- Polyethylene sump basin available with plastic unsealed covers in 18" x 22"
- Sewage basins are watertight and gastight when properly installed
- Durable steel cover with gasket standard on simplex and duplex sewage basins
- One piece, seamless construction on all basins
- Duplex covers include two pump plates and inspection plate
- Ready to install for economical and simple installation
- Dimensional Engineering data available
- Temperature rated 130°F
- Fiberglass models available that will pass the 10' water stack test (Refer to charts on pages 2 and 3) (L. A. - RR-5311)
- Various custom diameters & lengths available in fiberglass, consult factory. Also with 10' water stack test.

CONSULT FACTORY FOR LARGER SIZE BASINS OR SPECIAL APPLICATIONS.

18" SUMP BASIN COVERS AND EXTENSIONS																																		
<p>One Piece, Polyethylene Molded with 3" x 13" Opening.</p>  <p>P/N 17-0135</p>	<p>One Piece, Steel with 3" Vent, 1-1/2" Discharge, and Cord Grommet (Radon Lid).</p>  <p>P/N 17-0131</p>	<p>One Piece, Polyethylene with 1-1/2" Discharge and Cord Grommet.</p>  <p>P/N 17-0294</p>	<p>Basin Extensions, for use with PSF 18" diameter basins:</p> <p>31-1476 - 6" riser extension w/ hardware. 31-1473 - 12" riser extension w/ hardware.</p>  <p>P/N 31-1476</p>																															
SUMP BASINS		RADON BASINS																																
<table border="1" style="width:100%; border-collapse: collapse;"> <thead> <tr> <th>Size</th> <th></th> <th>Basin Material</th> <th>Inlet</th> <th>Pipe Seal</th> </tr> </thead> <tbody> <tr> <td rowspan="2">18" x 22"</td> <td>31-0444</td> <td>Poly</td> <td>N</td> <td>N</td> </tr> <tr> <td>31-0251</td> <td>Poly</td> <td>Y</td> <td>4"</td> </tr> <tr> <td rowspan="4">18" x 30"</td> <td>31-0158</td> <td>Poly - 10' Stack</td> <td>Y</td> <td>4"</td> </tr> <tr> <td>31-2229</td> <td>PSF</td> <td>Y</td> <td>N</td> </tr> <tr> <td>31-2325</td> <td>PSF</td> <td>N</td> <td>N</td> </tr> <tr> <td>31-2380</td> <td>PSF</td> <td>Y</td> <td>4"</td> </tr> </tbody> </table>		Size		Basin Material	Inlet	Pipe Seal	18" x 22"	31-0444	Poly	N	N	31-0251	Poly	Y	4"	18" x 30"	31-0158	Poly - 10' Stack	Y	4"	31-2229	PSF	Y	N	31-2325	PSF	N	N	31-2380	PSF	Y	4"	<p>18" x 22" Pair 31-0251 Polyethylene basin with 17-0131 radon cover 18" x 30" Pair 31-0158 Polyethylene basin with 17-0131 radon cover</p>  <p>P/N 31-0249</p>	
Size		Basin Material	Inlet	Pipe Seal																														
18" x 22"	31-0444	Poly	N	N																														
	31-0251	Poly	Y	4"																														
18" x 30"	31-0158	Poly - 10' Stack	Y	4"																														
	31-2229	PSF	Y	N																														
	31-2325	PSF	N	N																														
	31-2380	PSF	Y	4"																														
ADDITIONAL INFO FOR PSF BASINS																																		
Item No.	Description																																	
31-2229	PSF basin predrilled 4" inlet, no hub, no torque stops - 18" x 30"																																	
31-2325	PSF basin no hole, no hub, no torque stops - 18" x 30"																																	
31-2380	PSF basin predrilled 4" inlet, w/ 4" pipe seal, no torque stops																																	

Products may not be exactly as pictured.

NOTE: Polyethylene basins should be used for indoor installations only.

SIMPLEX SEWAGE BASINS		DUPLEX SEWAGE BASINS	
18" x 30" 24" x 30"	Polyethylene Structural Foam (PSF), Polyethylene or Fiberglass Polyethylene or Fiberglass	30" x 36" 36" x 36" 48" x 48"	Polyethylene or Fiberglass Polyethylene or Fiberglass Fiberglass
			
SIMPLEX BASIN AND COVER INCLUDES: Discharge and vent flange Cord seal 4" Inlet hub Gaskets and hardware		DUPLEX BASIN AND COVER INCLUDES: Discharge and vent flange Cord seals 4" inlet hub - cast iron shown Inspection plate Gaskets and hardware	
			

**18" & 24" DIAMETER BASIN AND COVERS
POLYETHYLENE/POLYETHYLENE STRUCTURAL FOAM/FIBERGLASS**

SIMPLEX BASINS & COVERS						
Size	2" Vent and Discharge*	Basin Material	IAPMO Listed	Cover Style	IAPMO Listed	4" Inlet
18" X 30"	31-0081	Poly	N	Steel-Split	N	Fiberglass Hub
18" X 30"	31-0091	Poly	Y	Steel-Solid	N	Fiberglass Hub
18" X 30"	31-0154	Fiberglass	N	Steel-Split	N	Cast Iron Hub
18" X 30"	31-0159	Poly	Y	Steel-Solid - 10' Stack	Y	Pipe Seal
18" X 30"	31-0214	Fiberglass	N	Steel-Solid - 10' Stack	Y	Cast Iron Hub
18" X 30"	31-0608	Poly (Integral Side Vent)	N	Poly-Solid	N	Pipe Seal
18" X 30"	31-0615	Poly	Y	Steel-Solid	N	Pipe Seal
18" X 30"	31-1098	PSF	N	Poly-Solid	N	Combo Hub
18" X 30"	31-1099	PSF	N	Poly-Solid	N	Combo Hub
18" X 30"	31-1338	PSF	N	Poly-Solid	N	Snap-In Hub
24" X 24"	31-1997	Poly	N	Poly-Solid	N	Pipe Seal
24" X 30"	31-0004	Fiberglass	N	Steel-Solid	N	Cast Iron Hub
24" X 30"	31-0039	Poly	N	Steel-Solid	N	Cast Iron Hub
24" X 30"	31-0218	Fiberglass	N	Steel-Solid - 10' Stack	Y	Cast Iron Hub
24" X 36"	31-1102	PSF	N	FG-Solid	N	Combo Hub

30", 36" & 48" DIAMETER BASINS AND COVERS - POLYETHYLENE/FIBERGLASS

DUPLEX BASINS & COVERS						
Size	2" Vent and Discharge*	Basin Material	IAPMO Listed	Cover Style	IAPMO Capable	4" Inlet
30" X 36"	31-1105	PSF	N	Solid-FG*- Duplex	N	Combo Hub
30" X 36"	31-0043	Poly	N	Steel-Solid - Duplex	N	Cast Iron Hub
30" X 36"	31-0071	Fiberglass	N	Steel-Solid - Duplex	N	Cast Iron Hub
30" X 36"	31-0222	Fiberglass	N	Steel-Solid - Duplex - 10' Stack	Y	Cast Iron Hub
36" X 36"	31-0047	Poly	N	Steel-Solid - Duplex	N	Cast Iron Hub
36" X 36"	31-0010	Fiberglass	N	Steel-Solid - Duplex - 10' Stack	Y	Cast Iron Hub
48" X 48"	31-0124	Fiberglass	N	Steel-Solid - Duplex - 10' Stack	Y	Cast Iron Hub

Hub Size (Flat Mount - Cast Iron)	Basin Size					
	18"	24"	30"	36"	42"	48"
4"	005198 (Fits all basins with a flat on side)					

Hub Size (Curved Mount - Cast Iron)	Basin Size					
	18"	24"	30"	36"	42"	48"
2"	010749	010749	010749	010749	010749	010749
3"	010124	010124	010124	010124	010124	010124
4"	NA	004997	004997	004997	004997	004997
6"	NA	007818	007818	007818	007818	007818
8"	NA	010057	010057	010057	010057	010057

Hub Size (Pipe Seal Grommets)	All Basin Sizes	Hole Size Required in Basin
1-1/4"	008813	2"
1-1/4"	009838	3"
1-1/2"	005882	2-1/2"
1-1/2"	009170	3"
2"	005588	3"
3"	005587	4"
4"	005196	5"
6"	009850	7"

Curved mount requires mounting on curved side of basin.

Hub Size (Combo Hub)	Basin Size (Poly structural foam only)		
	18"	24"	30"
3"	013505	013505	013505
4"	012094	012094	012094



BASIN DIMENSIONS									
Available in:		Fiber-glass	Size	Gallon Capacity	A	B	C	D	E
Str. Foam	Poly								
x	x	x	18" x 30"	30	30"	16 - 1/2" (18" FG)	18"	22"	10-1/2"
NA	x	x	24" x 30"	60	30"	24"	26" (24" FG)	30"	10-1/2"
x	NA	NA	24" x 36"	72	36"	22-1/2"	25-1/2"	30"	10-1/2"
NA	x	x	30" x 36"	108	36"	30"	32" (30" FG)	36"	10-1/2"
NA	x	x	36" x 36"	159	36"	36"	38" (36" FG)	42"	10-1/2"
NA	NA	x	48" x 48"	376	48"	48"	48"	55-1/2"	10-1/2"

BASIN DIMENSIONS							
Fiber Glass	Size	Gallon Capacity	A	B	C	D	E
x	18" x 30"	30	30"	18"	18"	22"	10-1/2"
x	24" x 30"	60	30"	24"	24"	30"	10-1/2"
x	30" x 36"	108	36"	30"	30"	36"	10-1/2"
x	36" x 36"	159	36"	36"	36"	42"	10-1/2"
x	48" x 48"	376	48"	48"	48"	55-1/2"	10-1/2"

THICKNESS OF BASINS			
Size	PSF	Poly	Fiberglass
18" x 30"	0.200	0.200	0.188
24" x 30"	N/A	0.200	0.188
24" x 36"	0.250	N/A	N/A
30" x 36"	0.312	0.230	0.188
36" x 36"	N/A	0.230	0.188
48" x 48"	N/A	N/A	0.250

THICKNESS OF COVERS					
Size	Steel Split	Steel Solid	Poly Solid	Poly Split	Fiberglass
18"	0.075	0.115	0.345	0.312	N/A
24"	N/A	0.115	N/A	0.343	N/A
30"	N/A	0.125	N/A	N/A	0.250
36"	N/A	0.125	N/A	N/A	0.375
48"	N/A	0.250	N/A	N/A	0.500

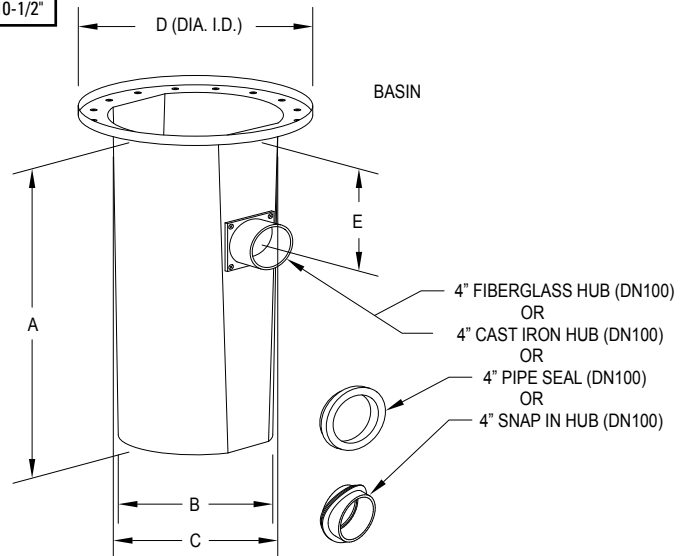

SK1866D

CONSULT FACTORY FOR LARGER SIZE BASINS OR SPECIAL APPLICATIONS.

NOTE: Basins are not designed to be installed where saturated soil hydrostatic pressure extends above the top of the pit unless the pressure is relieved by an independent drainage system. Basin cover vent and discharge seals may be rubber insert or bolted on flange design.

OUTDOOR BASINS AND ACCESSORIES

OUTDOOR BASINS - FIBERGLASS ONLY - NO HOLES DRILLED			
Size	Item No.	Simplex / Duplex	Description
24" X 48"	31-0866	Simplex	Solid Fiberglass Basin with Solid Fiberglass Cover and Anti-Flotation Ring
24" X 60"	31-0946	Simplex	Solid Fiberglass Basin with Solid Fiberglass Cover and Anti-Flotation Ring
24" X 72"	31-0594	Simplex	Solid Fiberglass Basin with Solid Fiberglass Cover and Anti-Flotation Ring
30" X 48"	31-1830	Simplex	Solid Fiberglass Basin with Solid Fiberglass Cover and Anti-Flotation Ring
30" X 60"	31-1831	Simplex	Solid Fiberglass Basin with Solid Fiberglass Cover and Anti-Flotation Ring
30" X 72"	31-1586	Simplex	Solid Fiberglass Basin with Solid Fiberglass Cover and Anti-Flotation Ring
36" X 48"	31-1450	Simplex or Duplex	Solid Fiberglass Basin with Solid Fiberglass Cover and Anti-Flotation Ring
36" X 60"	31-1451	Simplex or Duplex	Solid Fiberglass Basin with Solid Fiberglass Cover and Anti-Flotation Ring
36" X 72"	31-1452	Simplex or Duplex	Solid Fiberglass Basin with Solid Fiberglass Cover and Anti-Flotation Ring

All basins include 5 field installed adapta-flex seals - (1) 1-1/4", (1) 1-1/2", (2) 2" and (1) 4" grommets.

Additional basin sizes with options (i.E. Rail studs) are available. Consult factory.

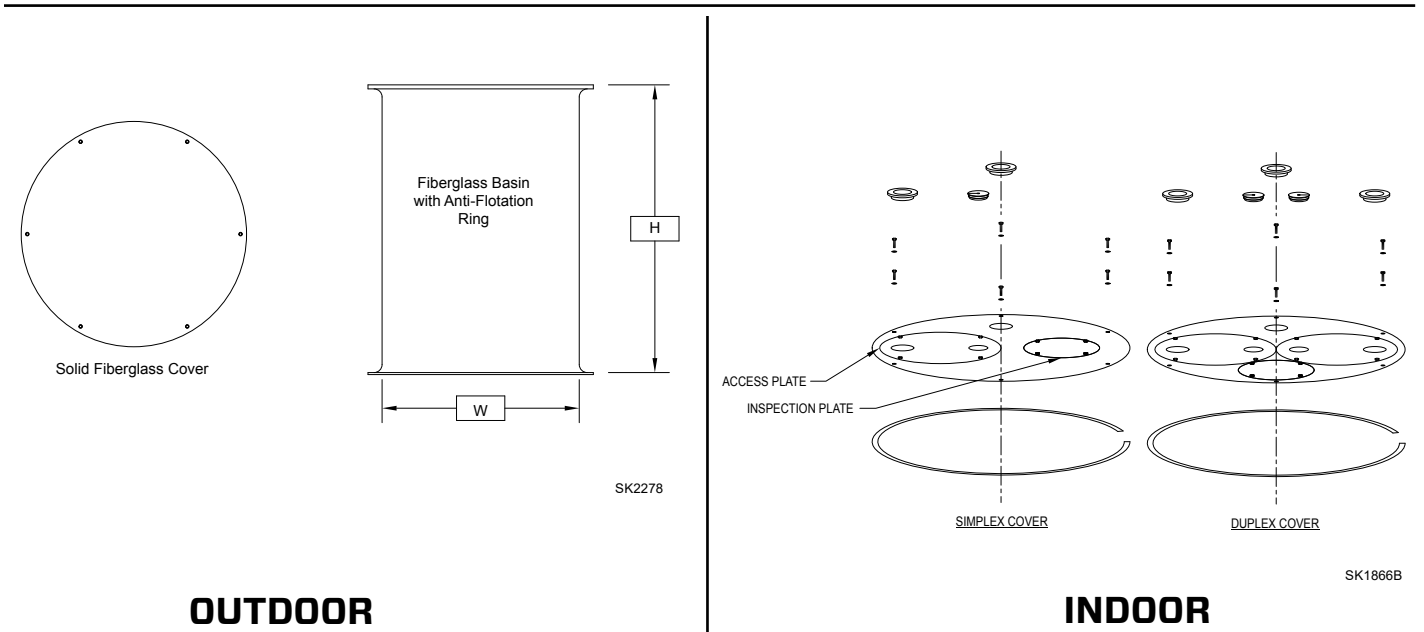

OUTDOOR

INDOOR

OUTDOOR TANK VENTS						
Item No.	Color	Material	Size	Dimension (W x H)	Pipe Area	Screen Area
10-1753	Black	Plastic	2" Female NPT	4.625" X 3.125"	3.1 sq. in.	6.9 sq. in.
10-1461	Green	Metal	2" Female NPT	4.625" X 3.125"	3.1 sq. in.	6.9 sq. in.
10-1462	Green	Metal	3" Female NPT	6.875" X 4.500"	7.1 sq. in.	19.6 sq. in.
10-1463	Green	Metal	4" Female NPT	9.250" X 5.000"	12.6 sq. in.	35.8 sq. in.
10-1464	Green	Metal	6" Female NPT	11.125" X 6.625"	28.3 sq. in.	42.5 sq. in.



MAIL TO: P.O. BOX 16347 • Louisville, KY 40256-0347
 SHIP TO: 3649 Cane Run Road • Louisville, KY 40211-1961
 (502) 778-2731 • 1 (800) 928-PUMP • FAX (502) 774-3624

Trusted. Tested. Tough.®

Visit our website:
zoellerpumps.com